

### Input data

System of measurement		Metric
Input type		Coupling for electric motor
Input speed	[rpm]	1400
Output speed	[rpm]	200
Ratio (i=)		7
Frequency	[Hz]	50
Input options		IEC
Requested input power	[kW]	1.5
Service factor		1.8
Rated Power P1	[kW]	2.75

### Output data

#### **Gear unit** F RT 60 B3 7 90 B14 AC 25

Type		RT - Worm speed reducers
Input type		F (Elastic coupling)
Size		60
Ratio (i=)		7
Input flange		B14
Input speed	[rpm]	1400
Output speed	[rpm]	200
Rated output torque	[Nm]	61.6
Service Factor		1.8
Efficiency		0.86
Inertia moment	[kgm <sup>2</sup> ]	0.000134

#### **Gear unit configuration**

Output shaft		Hollow output shaft
Fixing		Universal
Version		B3

#### **Output radial and axial loads**

Ball bearings output radial load	[N]	2400
Taper bearings output radial load	[N]	3000
Ball bearings output axial load	[N]	480
Taper bearings output axial load	[N]	600

#### **Accessories**

Hollow output shaft		AC 25
---------------------	--	-------

#### **Electric motor coupling**

Size		90 L4
Poles n.		4
Power	[kW]	1.5

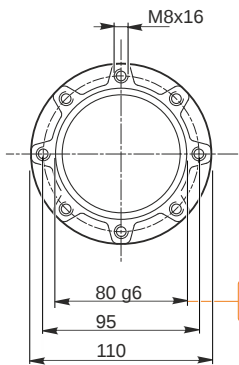
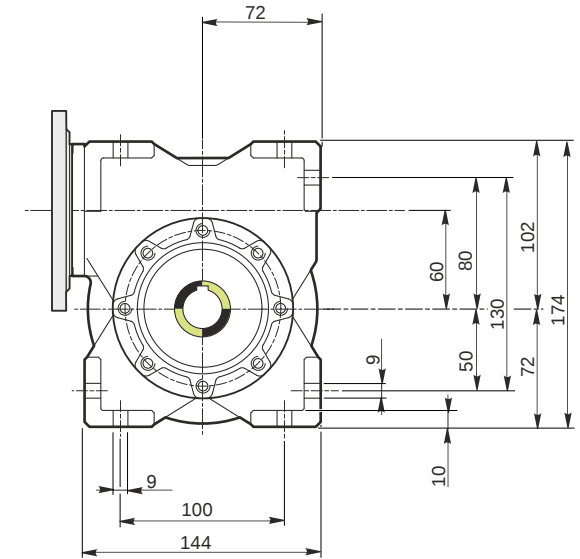
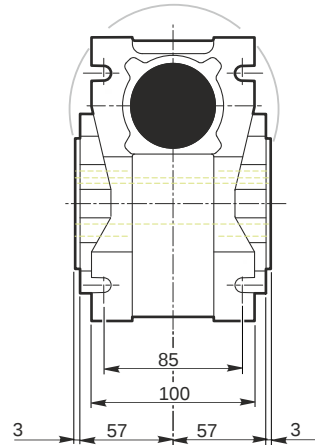
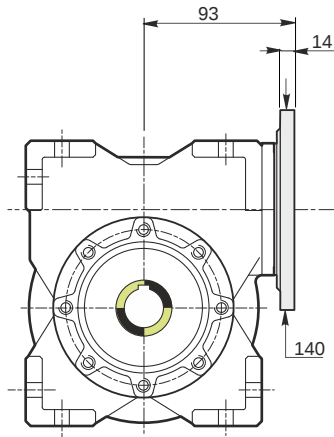

*Hollow output shaft*

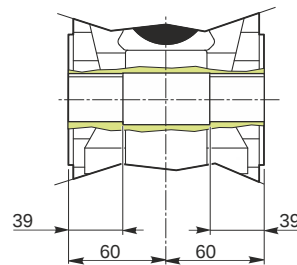
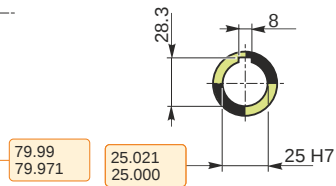

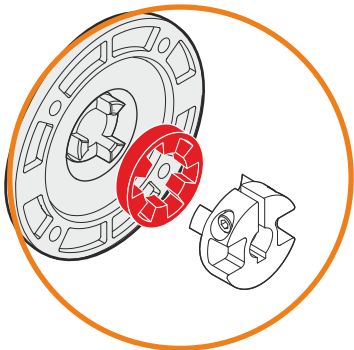
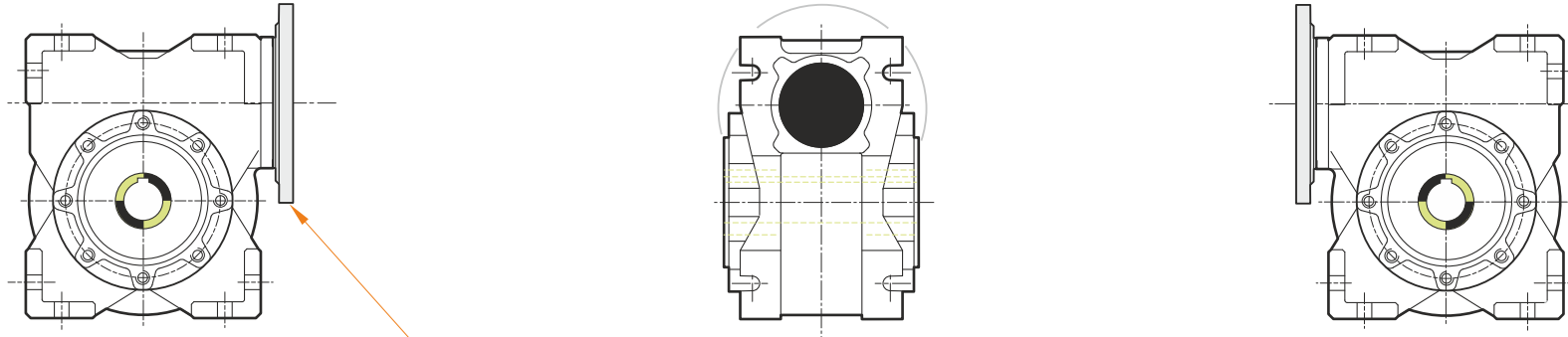

This gear unit is provided with an elastic coupling motor fitting

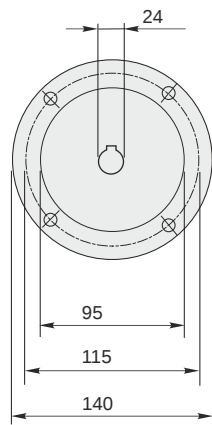

**Mounting positions**

**B3**

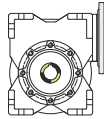

**B6**

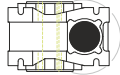

**B7**

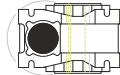

**B8**

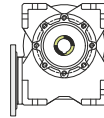

**V5**

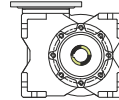

**V6**

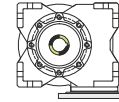

0.23



← Oil quantity [litres]

Lubricant type: Long life synthetic oil ISO VG320

**Direction of rotation**

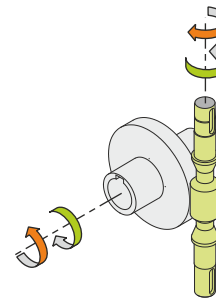
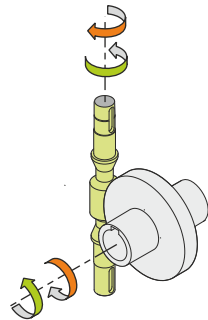
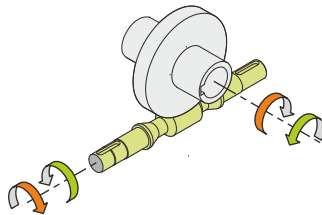
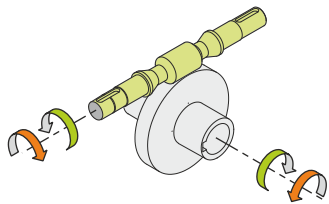

**Weight**

Gear unit [kg] 6.5

**Gearing data**

Axial module	3.3
Number of starts	4
Lead angle	25° 33'
Pressure angle	20°

**Backdriving**

Static back-driving  
Quick back-driving  
Dynamic back-driving